

## DS-2CE72HFT-E

### 5 MP ColorVu PoC Fixed Turret Camera



- High quality imaging with 5 MP, 2560 × 1944 resolution
- 24/7 color imaging
- Clear imaging against strong back light due to 130 dB true WDR technology
- 3D DNR technology delivers clean and sharp images
- 2.8 mm, 3.6 mm fixed focal lens
- Smart Light, up to 20 m white light distance
- Water and dust resistant (IP67)



## ▪ Specification





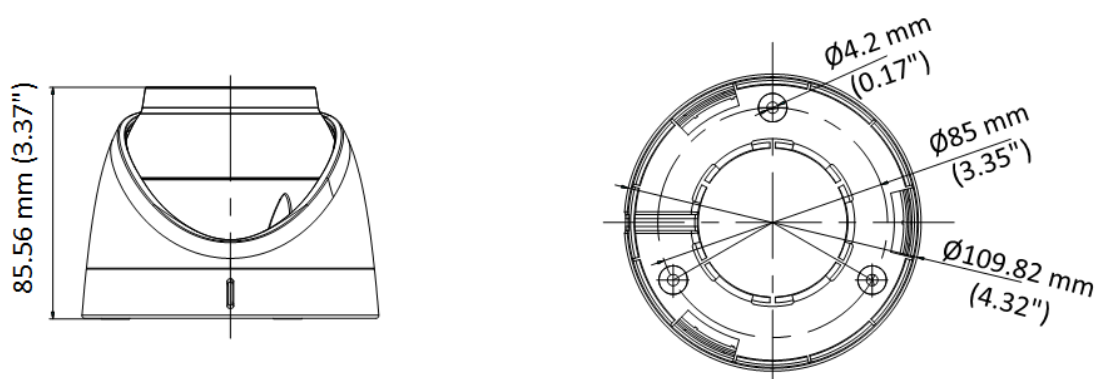

Specification	
Image Sensor	5 MP CMOS
Signal System	PAL/NTSC
Resolution	2560 (H) × 1944 (V)
Frame Rate	5 MP @ 20 fps, 4 MP @ 30 fps, 4 MP @ 25 fps, 1080p @ 30 fps, 1080p @ 25 fps
Min. Illumination	0.0005 Lux @ (F1.0, AGC ON), 0 Lux with white light
Shutter Time	PAL: 1/25 s to 1/50,000 s; NTSC: 1/30 s to 1/50,000 s
Lens	2.8 mm, 3.6 mm fixed focal lens
Field of View	2.8 mm, horizontal FOV: 99.7°, vertical FOV: 72°, diagonal FOV: 139.8° 3.6 mm, horizontal FOV: 80.1°, vertical FOV: 58.6°, diagonal FOV: 106.2°
Lens Mount	M16
Light Alarm	Solid Light Alarm (White Light)
WDR (Wide Dynamic Range)	≥130 dB
Angle Adjustment	Pan: 0° to 360°, Tilt: 0° to 75°, Rotation: 0° to 360°
Menu	
White Light	Auto/Off
Image Mode	STD/HIGH-SAT
AGC	Yes
Day/Night Mode	Color
White Balance	Auto/Manual
AE (Auto Exposure) Mode	WDR, BLC, HLC, Global, HLS
Noise Reduction	3D DNR/2D DNR
Language	English
Function	Brightness, Mirror, Sharpness, Anti-Banding, Smart Light
Interface	
Video Output	1 HD analog output
General	
Operating Conditions	-40°C to 60°C (-40°F to 140°F), Humidity: 90% or less (non-condensing)
Power Supply	12 VDC±25%/PoC.af <i>*You are recommended to use one power adapter for one camera, and use 2-pin power supply for long-distance power supply.</i>
Consumption	Max. 4 W
Protection Level	IP67
Material	Enclosure: Plastic Main body: Metal
White Light Range	Up to 20 m
Communication	HIKVISION-C
Dimension	Φ 109.82 mm × 85.56 mm (4.32" × 3.37")
Weight	Approx. 350 g (0.77 lb.)

## ▪ Dimension

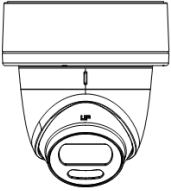
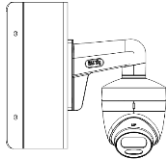
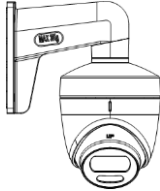
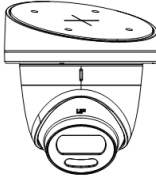
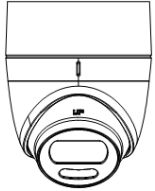

## ▪ Accessory

▪ **Optional**

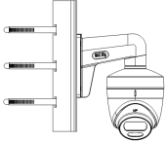
DS-1280ZJ-S Junction box	DS-1276ZJ-SUS Corner mount	DS-1272ZJ-110-TRS Wall mount	DS-1281ZJ-S Inclined ceiling mount	DS-1280ZJ-TR13 Junction box
				
				
<p><b>DS-1275ZJ-SUS</b> <b>Vertical pole mount</b></p>				
				
				

▪ **Available Model**

DS-2CE72HFT-E



Distributed by

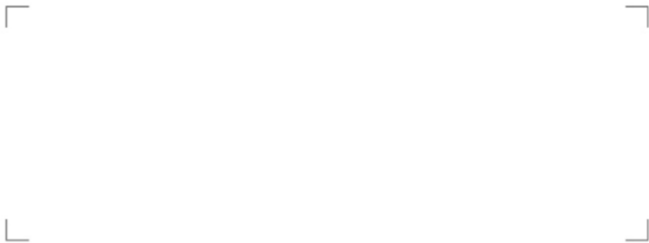

## **HIKVISION®**

### **Headquarters**

No.555 Qianmo Road, Binjiang District,  
Hangzhou 310051, China  
T +86-571-8807-5998  
overseasbusiness@hikvision.com

### **Hikvision USA**

T +1-909-895-0400  
sales.usa@hikvision.com

### **Hikvision Australia**

T +61-2-8599-4233  
salesau@hikvision.com

### **Hikvision India**

T +91-22-28469900  
sales@pramahikvision.com

### **Hikvision Canada**

T +1-866-200-6690  
sales.canada@hikvision.com

### **Hikvision Thailand**

T +662-275-9949  
sales.thailand@hikvision.com

### **Hikvision Europe**

T +31-23-5542770  
sales.eu@hikvision.com

### **Hikvision Italy**

T +39-0438-6902  
info.it@hikvision.com

### **Hikvision Brazil**

T +55 11 3318-0050  
Latam.support@hikvision.com

### **Hikvision Turkey**

T +90 (216)521 7070- 7074  
sales.tr@hikvision.com

### **Hikvision Malaysia**

T +601-7652-2413  
sales.my@hikvision.com

### **Hikvision UK & Ireland**

T +01628-902140  
sales.uk@hikvision.com

### **Hikvision South Africa**

Tel: +27 (10) 0351172  
sale.africa@hikvision.com

### **Hikvision France**

T +33(0)1-85-330-450  
info.fr@hikvision.com

### **Hikvision Kazakhstan**

T +7-727-9730667  
nikia.panfilov@hikvision.ru

### **Hikvision Vietnam**

T +84-974270888  
sales.vt@hikvision.com

### **Hikvision UAE**

T +971-4-4432090  
salesme@hikvision.com

### **Hikvision Singapore**

T +65-6684-4718  
sg@hikvision.com

### **Hikvision Spain**

T +34-91-737-16-55  
info.es@hikvision.com

### **Hikvision Tashkent**

T +99-87-1238-9438  
uzb@hikvision.ru

### **Hikvision Hong Kong**

T +852-2151-1761  
info.hk@hikvision.com

### **Hikvision Russia**

T +7-495-669-67-99  
saleru@hikvision.com

### **Hikvision Korea**

T +82-(0)31-731-8817  
sales.korea@hikvision.com

### **Hikvision Poland**

T +48-22-460-01-50  
info.pl@hikvision.com

### **Hikvision Indonesia**

T +62-21-2933759  
Sales.Indonesia@hikvision.com

### **Hikvision Colombia**

sales.colombia@hikvision.com